



ALUGZA-B-DSG-02
SOLAR PRODUCT CATALOG

PRODUCT NAME	PRODUCT NUMBER	WEIGHT (gr/m)	PRODUCT DIMENSIONS (mm)
PROFILE	D22-1-0001-1-3127	3138	
PROFILE	D22-1-0002-1-3128	2671	
PROFILE	D22-1-0003-1-3132	1019	
PROFILE	D22-1-0004-1-2747	1245	
PROFILE	D22-1-0005-1-2835	1405	

PROFILE	D22-1-0006-1-3047	1462	<p>3047 - 1462gr/m</p>
PROFILE	D22-1-0007-1-3126	1038	<p>3126 - 1038gr/m</p>
PROFILE	D22-1-0008-1-11266	1048	<p>11266 - 1048 gr/m</p>
PROFILE	D22-1-0009-1-11280	1366	<p>11280 - 1366 gr/m</p>
PROFILE	D22-1-0010-1-11437	832	<p>11437 - 832 gr/m</p>
PROFILE	D22-1-0011-1-9126	757	<p>9126 - 757 gr/m</p>

PROFILE	D22-1-0012-1-9127	813	<p>40</p> <p>40</p> <p>9127 - 813 gr/m</p>
PROFILE	D22-1-0013-1-9128	841	<p>40</p> <p>40</p> <p>9128 - 841 gr/m</p>
PROFILE	D22-1-0014-1-9129	921	<p>40</p> <p>40</p> <p>9129 - 921 gr/m</p>
PROFILE	D22-1-0015-1-9130	763	<p>40</p> <p>40</p> <p>9130 - 763 gr/m</p>
PROFILE	D22-1-0016-1-9134	1204	<p>80</p> <p>40</p> <p>9134 - 1204 gr/m</p>
PROFILE	D22-1-0017-1-9746	883	<p>40</p> <p>40</p> <p>9746 - 883 gr/m</p>

PROFILE	D22-1-0018-1-9747	756	<p>80 40 9747 - 756 gr/m</p>
PROFILE	D22-1-0019-1-8214	751	<p>37 30 8214 - 751 gr/m</p>
PROFILE	D22-1-0020-1-8215	1011	<p>90 8215 - 1011 gr/m</p>
PROFILE	D22-1-0021-1-8439	929	<p>39 39,5 8439 - 929 gr/m</p>
PROFILE	D22-1-0022-1-8440	1234	<p>50 79,5 8440 - 1234 gr/m</p>
PROFILE	D22-1-0023-1-8441	959	<p>36,8 38,5 8441 - 959 gr/m</p>

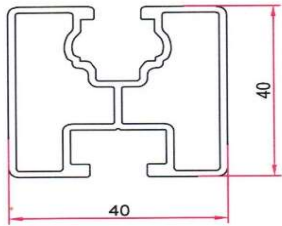
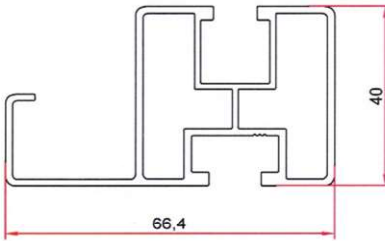
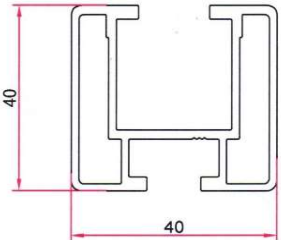
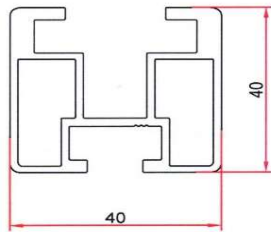
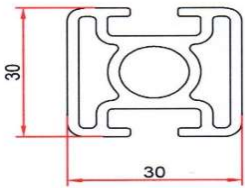
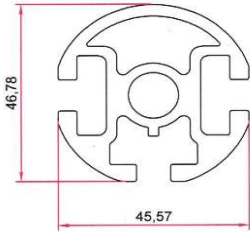
PROFILE	D22-1-0024-1-8938	924	 <p>8938 - 924 gr/m</p>
PROFILE	D22-1-0025-1-7793	1122	 <p>7793 - 1122 gr/m</p>
PROFILE	D22-1-0026-1-7794	1033	 <p>7794 - 1033 gr/m</p>
PROFILE	D22-1-0027-1-7795	1138	 <p>7795 - 1138 gr/m</p>
PROFILE	D22-1-0028-1-7976	991	 <p>7976 - 991 gr/m</p>
PROFILE	D22-1-0029-1-7977	2036	 <p>7977 - 2036 gr/m</p>

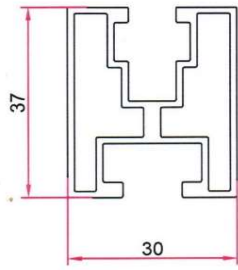
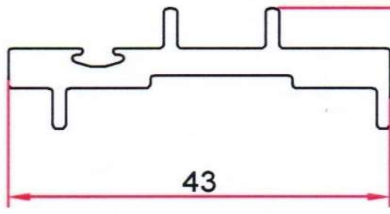
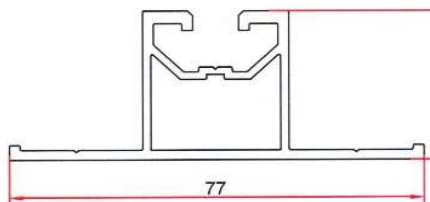
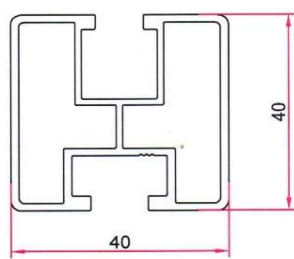
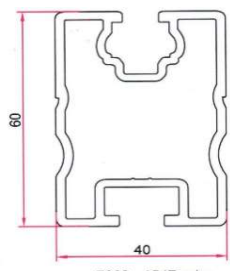
PROFILE	D22-1-0030-1-8214	751	 <p>8214 - 751 gr/m</p>
PROFILE	D22-1-0031-1-7301	566	 <p>7301 - 566 gr/m</p>
PROFILE	D22-1-0032-1-7738	913	 <p>7738 - 913 gr/m</p>
PROFILE	D22-1-0033-1-7792	933	 <p>7792 - 933 gr/m</p>
PROFILE	D22-1-0034-1-7202	1547	 <p>7202 - 1547 gr/m</p>

PROFILE	D22-1-0035-1-7068	1237	<p>42,5 1,5 103,8 7068 - 1237 gr/m</p>
PROFILE	D22-1-0036-1-7212	1113	<p>42 40 7212 - 1113 gr/m</p>
PROFILE	D22-1-0037-1-7242	806	<p>38 39,5 7242 - 806 gr/m</p>
PROFILE	D22-1-0038-1-7255	1461	<p>37 59,5 7255 - 1461 gr/m</p>
PROFILE	D22-1-0039-1-7009	1142	<p>50 50 7009 - 1142 gr/m</p>
PROFILE	D22-1-0040-1-7049	934	<p>40 40 7049 - 934 gr/m</p>

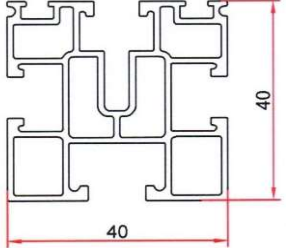
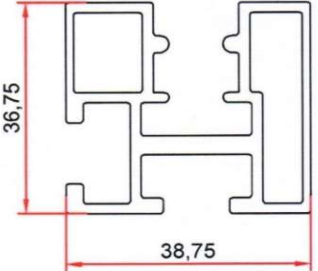
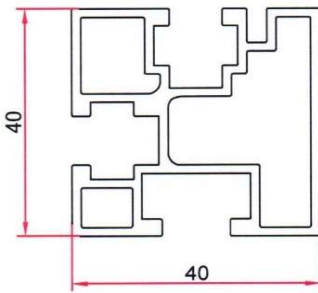
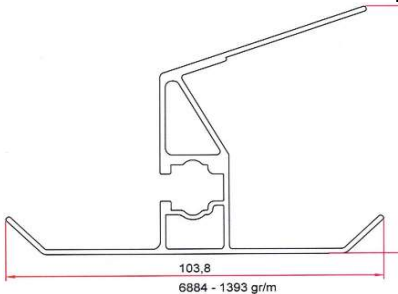
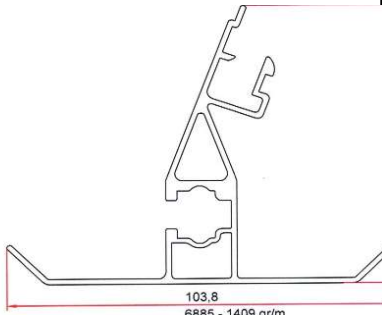
PROFILE	D22-1-0042-1-6993	1021	 <p>40 40 6993 - 1021 gr/m</p>
PROFILE	D22-1-0043-1-6789	1077	 <p>36,75 38,75 6789 - 1077 gr/m</p>
PROFILE	D22-1-0044-1-6827	1094	 <p>40 40 6827 - 1094 gr/m</p>
PROFILE	D22-1-0045-1-6884	1393	 <p>103,8 6884 - 1393 gr/m</p>
PROFILE	D22-1-0046-1-6885	1409	 <p>103,8 6885 - 1409 gr/m</p>

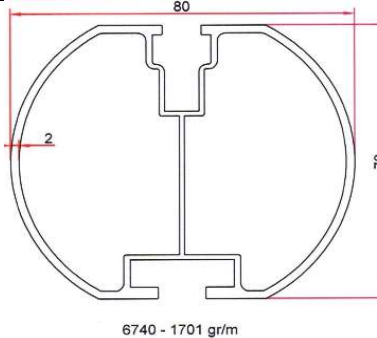
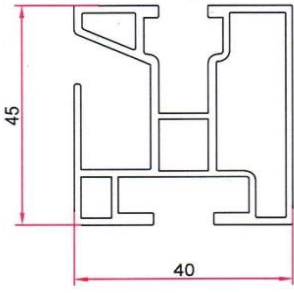
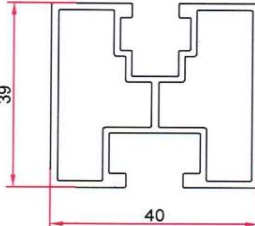
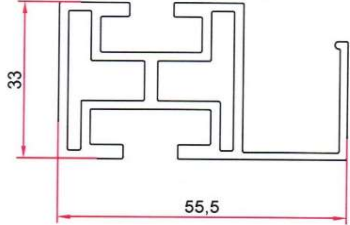
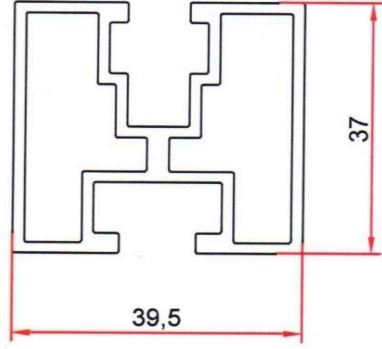
PROFILE	D22-1-0047-1-6740	1701	 <p>6740 - 1701 gr/m</p>
PROFILE	D22-1-0048-1-6742	1045	 <p>6742 - 1045 gr/m</p>
PROFILE	D22-1-0049-1-4324	856	 <p>4324 - 856 gr/m</p>
PROFILE	D22-1-0050-1-3348	1263	 <p>3348 - 1263 gr/m</p>
PROFILE	D22-1-0051-1-3229	1020	 <p>3229 - 1020 gr/m</p>

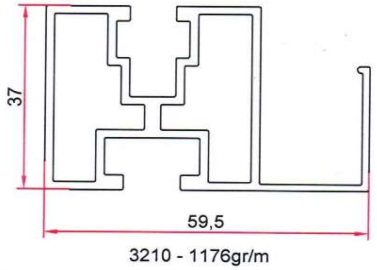
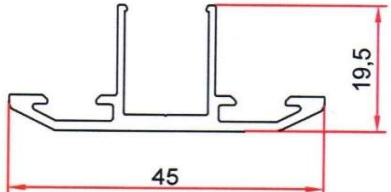
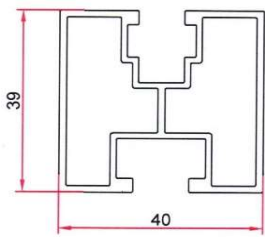
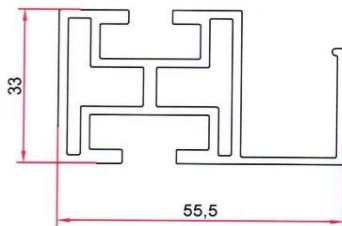
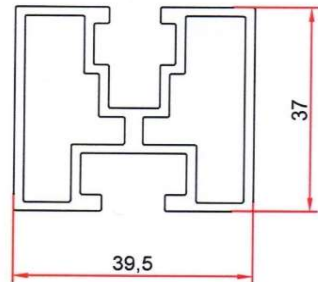
PROFILE	D22-1-0052-1-3210	1176	 <p>3210 - 1176gr/m</p>
PROFILE	D22-1-0053-1-3167	383	 <p>3167 - 383 gr/m</p>
PROFILE	D22-1-0054-1-4324	856	 <p>4324 - 856 gr/m</p>
PROFILE	D22-1-0055-1-3348	1263	 <p>3348 - 1263 gr/m</p>
PROFILE	D22-1-0056-1-3229	1020	 <p>3229 - 1020 gr/m</p>

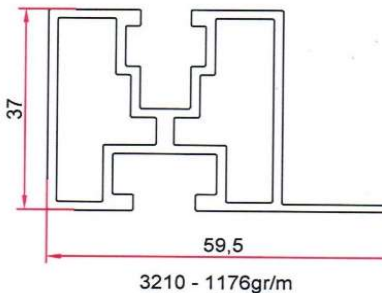
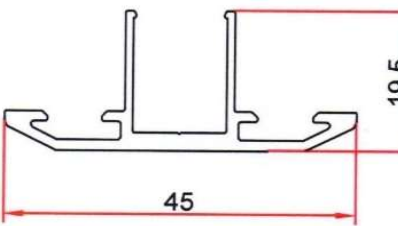
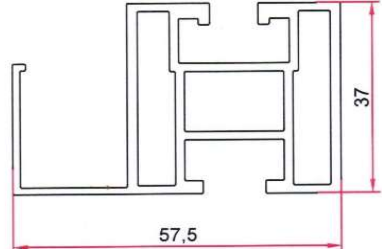
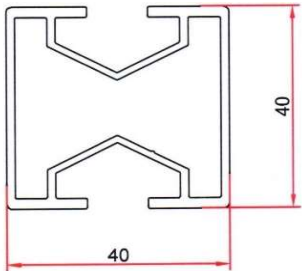
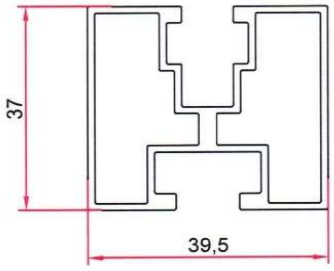
PROFILE	D22-1-0057-1-3210	1176	 <p>3210 - 1176gr/m</p>
PROFILE	D22-1-0058-1-3167	383	 <p>3167 - 383 gr/m</p>
PROFILE	D22-1-0059-1-4669	1212	 <p>4669 - 1212 gr/m</p>
PROFILE	D22-1-0060-1-4620	894	 <p>4620 - 894 gr/m</p>
PROFILE	D22-1-0061-1-4372	811	 <p>4372 - 811 gr/m</p>

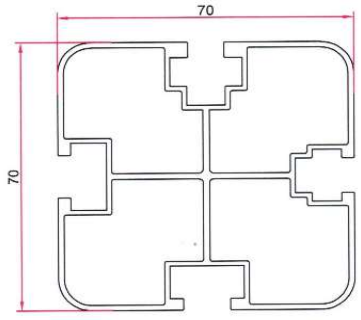
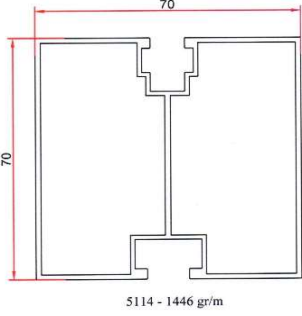
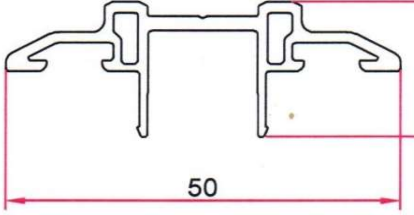
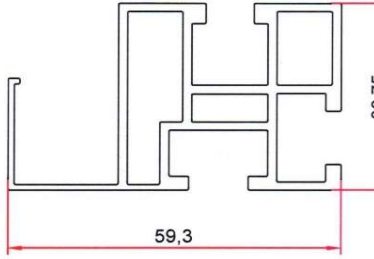
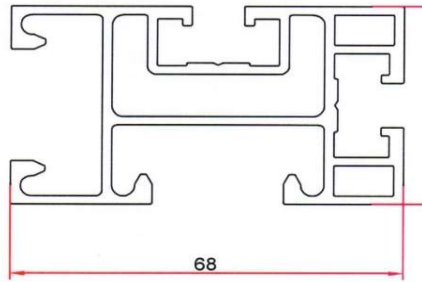

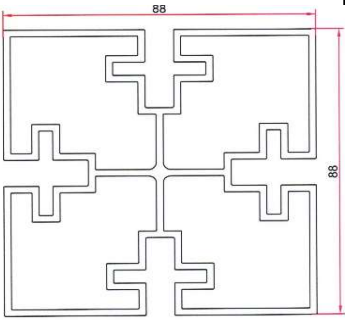
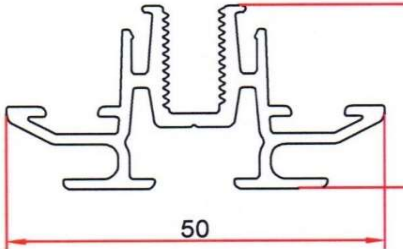
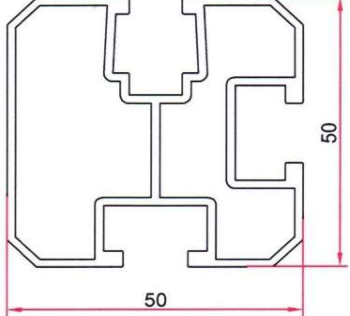
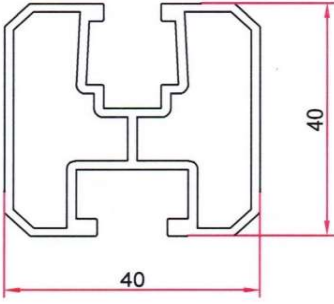
PROFILE	D22-1-0062-1-5115	1858	 <p>70</p> <p>70</p> <p>5115 - 1858 gr/m</p>
PROFILE	D22-1-0063-1-5114	1446	 <p>70</p> <p>70</p> <p>5114 - 1446 gr/m</p>
PROFILE	D22-1-0064-1-5336	451	 <p>50</p> <p>5336 - 451 gr/m</p>
PROFILE	D22-1-0065-1-5267	1166	 <p>59,3</p> <p>5267 - 1166 gr/m</p>
PROFILE	D22-1-0066-1-5210	1731	 <p>68</p> <p>5210 - 1731 gr/m</p>

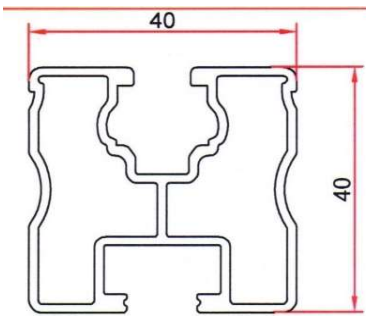
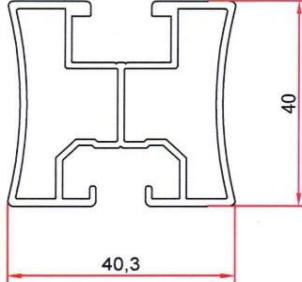
PROFILE	D22-1-0067-1-5536	4061	 <p>5536 - 4061 gr/m</p>
PROFILE	D22-1-0068-1-5337	728	 <p>5337 - 728 gr/m</p>
PROFILE	D22-1-0069-1-5631	1249	 <p>5631 - 1249 gr/m</p>
PROFILE	D22-1-0070-1-5630	918	 <p>5630 - 918 gr/m</p>

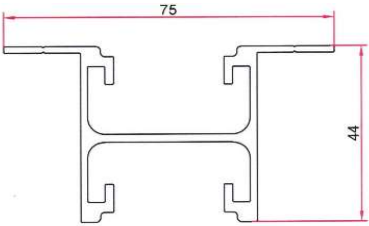
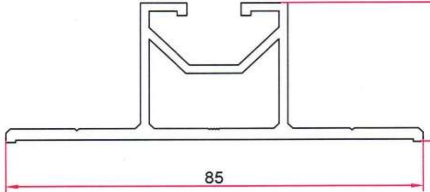
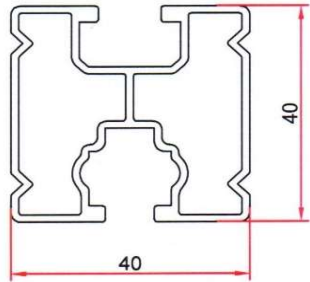
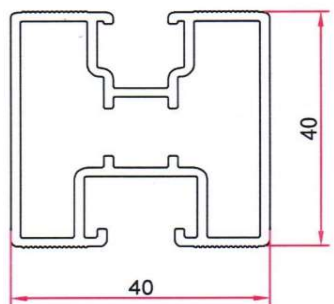
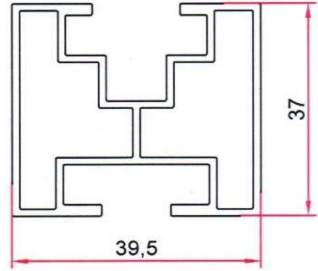
PROFILE	D22-1-0071-1-5622	934	 <p data-bbox="1125 593 1284 616">5622 - 934 gr/m</p>
PROFILE	D22-1-0072-1-5897	837	 <p data-bbox="1157 952 1300 974">5897 - 837 gr/m</p>

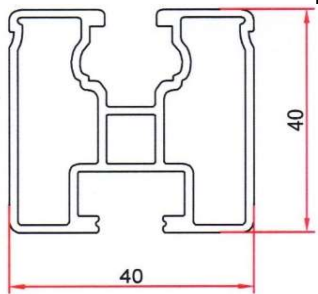
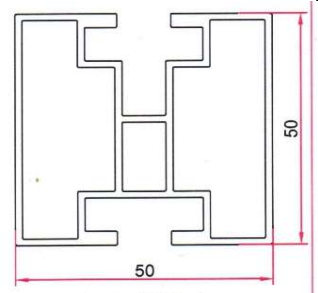
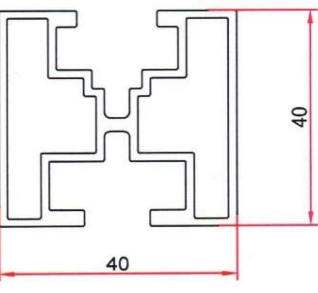
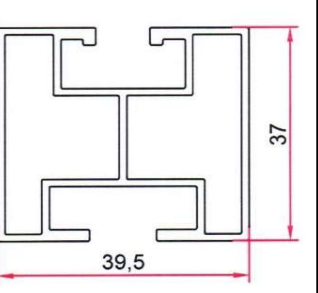
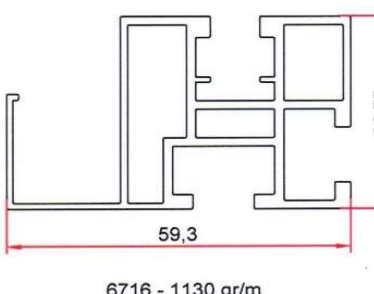

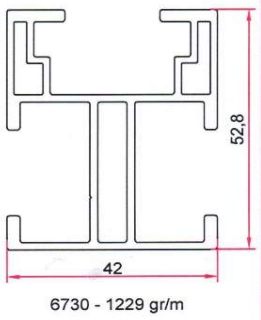
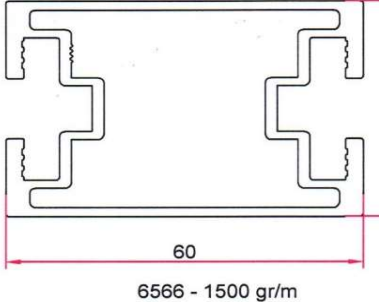
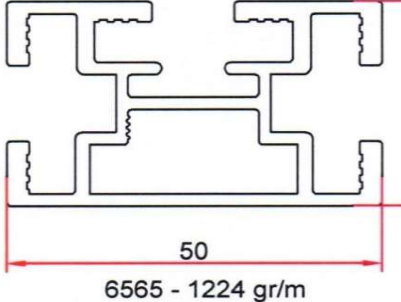
PROFILE	D22-1-0073-1-6562	1116	 <p>6562 - 1116 gr/m</p>
PROFILE	D22-1-0074-1-6440	1096	 <p>6440 - 1096 gr/m</p>
PROFILE	D22-1-0075-1-6411	888	 <p>6411 - 888 gr/m</p>
PROFILE	D22-1-0076-1-6269	918	 <p>6269 - 918 gr/m</p>
PROFILE	D22-1-0077-1-6140	789	 <p>6140 - 789 gr/m</p>

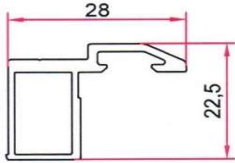
PROFILE	D22-1-0078-1-6064	966	 <p>6064 - 966 gr/m</p>
PROFILE	D22-1-0079-1-6741	1295	 <p>6741 - 1295 gr/m</p>
PROFILE	D22-1-0080-1-6556	1030	 <p>6556 - 1030 gr/m</p>
PROFILE	D22-1-0081-1-6710	797	 <p>6710 - 797 gr/m</p>
PROFILE	D22-1-0082-1-6716	1130	 <p>6716 - 1130 gr/m</p>

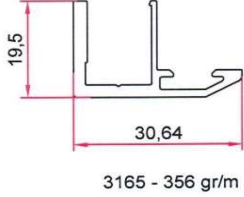
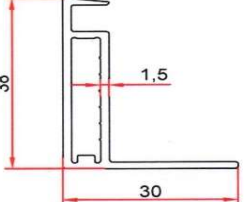
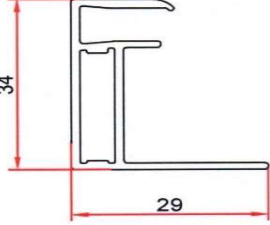
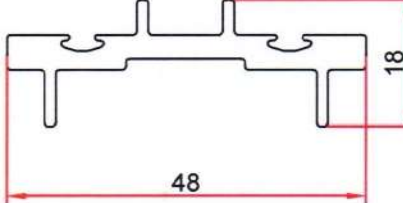
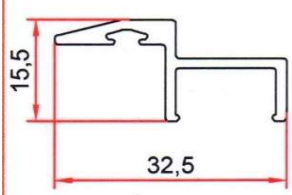
PROFILE	D22-1-0083-1-6730	1229	 <p>6730 - 1229 gr/m</p>
PROFILE	D22-1-0084-1-6566	1500	 <p>6566 - 1500 gr/m</p>
PROFILE	D22-1-0085-1-6565	1224	 <p>6565 - 1224 gr/m</p>
		ALUGZA-B-DSG-02 SOLAR PRODUCT CATALOG	
PRODUCT NAME	PRODUCT NUMBER	WEIGHT (gr/m)	PRODUCT DIMENSIONS (mm)
FRAME	D22-1-0001-2-3164	317	 <p>3164 - 317 gr/m</p>

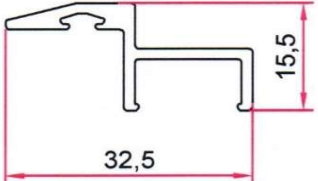
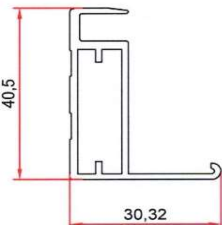
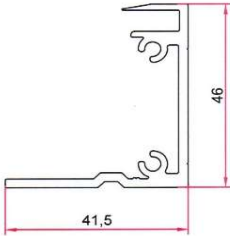
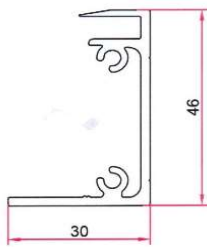
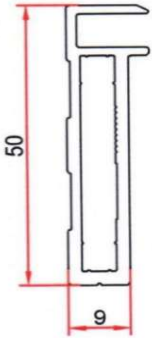

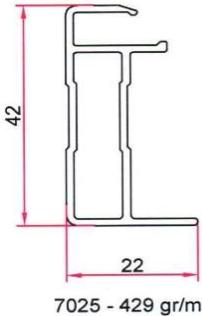
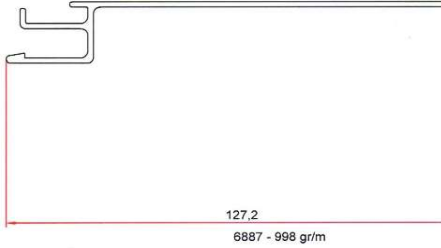
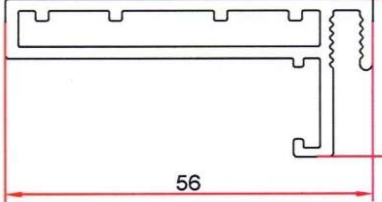
FRAME	D22-1-0002-2-3165	356	 <p>3165 - 356 gr/m</p>
FRAME	D22-1-0003-2-2719	437	 <p>2719 - 437 gr/m</p>
FRAME	D22-1-0004-2-3015	412	 <p>3015 - 412gr/m</p>
FRAME	D22-1-0005-2-7300	632	 <p>7300 - 632 gr/m</p>
FRAME	D22-1-0006-2-7303	262	 <p>7303 - 262 gr/m</p>

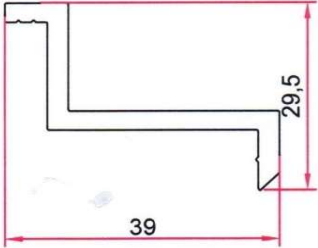
FRAME	D22-1-0007-2-7304	259	 <p>7304 - 259 gr/m</p>
FRAME	D22-1-0008-2-7327	492	 <p>7327 - 492 gr/m</p>
FRAME	D22-1-0009-2-7557	737	 <p>7557 - 737 gr/m</p>
FRAME	D22-1-0010-2-7558	613	 <p>7558 - 613 gr/m</p>
FRAME	D22-1-0011-2-7240	562	 <p>7240 - 562 gr/m</p>

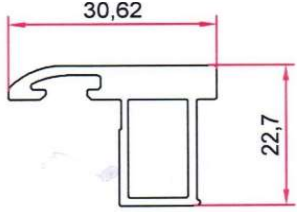
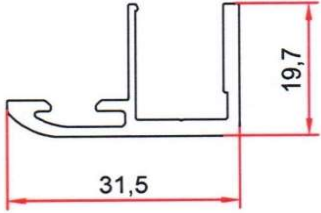
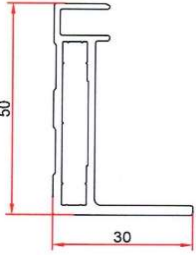
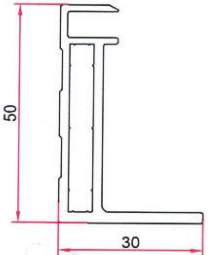
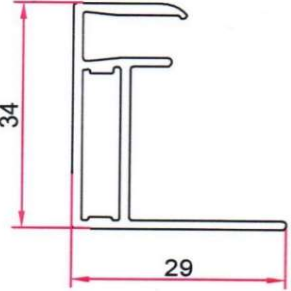
FRAME	D22-1-0012-2-7025	429	 <p>7025 - 429 gr/m</p>
FRAME	D22-1-0013-2-6887	998	 <p>6887 - 998 gr/m</p>
FRAME	D22-1-0014-2-6893	833	 <p>6893 - 833 gr/m</p>
FRAME	D22-1-0015-2-6951	635	 <p>6951 - 635 gr/m</p>
FRAME	D22-1-0016-2-6998	521	 <p>6998 - 521 gr/m</p>

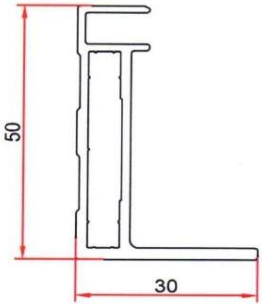
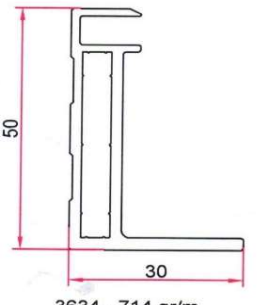
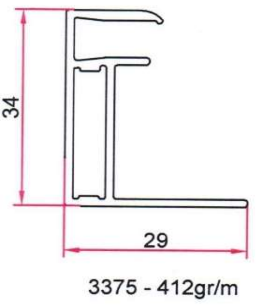
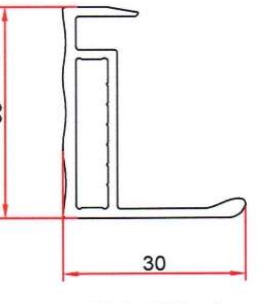
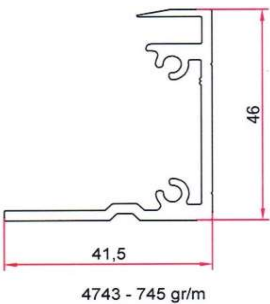
FRAME	D22-1-0017-2-6759	496	 <p>6759 - 496 gr/m</p>
FRAME	D22-1-0018-2-6760	366	 <p>6760 - 366 gr/m</p>
FRAME	D22-1-0019-2-3794	640	 <p>3794 - 640 gr/m</p>
FRAME	D22-1-0020-2-3634	714	 <p>3634 - 714 gr/m</p>
FRAME	D22-1-0021-2-3375	412	 <p>3375 - 412gr/m</p>

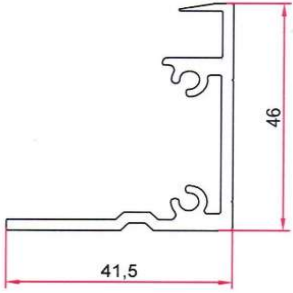
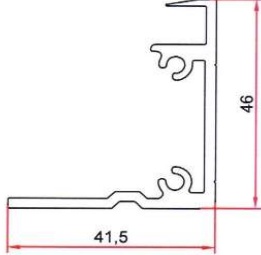
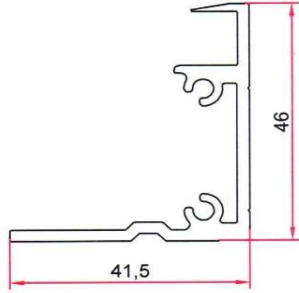
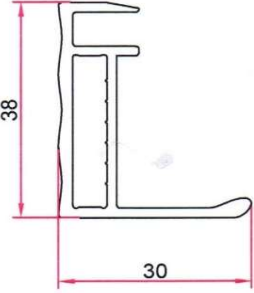
FRAME	D22-1-0022-2-3794	640	 <p>3794 - 640 gr/m</p>
FRAME	D22-1-0023-2-3634	714	 <p>3634 - 714 gr/m</p>
FRAME	D22-1-0024-2-3375	412	 <p>3375 - 412gr/m</p>
FRAME	D22-1-0025-2-4938	527	 <p>4938 - 527 gr/m</p>
FRAME	D22-1-0026-2-4743	745	 <p>4743 - 745 gr/m</p>

FRAME	D22-1-0027-2-5181	721	 <p>5181 - 721 gr/m</p>
FRAME	D22-1-0028-2-5122	722	 <p>5122 - 722 gr/m</p>
FRAME	D22-1-0029-2-5343	721	 <p>5343 - 721 gr/m</p>
FRAME	D22-1-0030-2-5862	541	 <p>5862 - 541 gr/m</p>
		ALUGZA-B-DSG-02 SOLAR PRODUCT CATALOG	
PRODUCT NAME	PRODUCT NUMBER	WEIGHT (gr/m)	PRODUCT DIMENSIONS (mm)

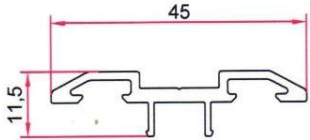
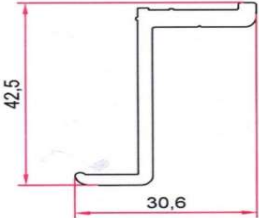
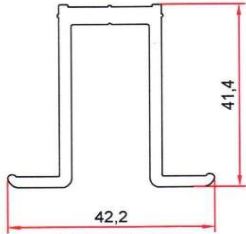
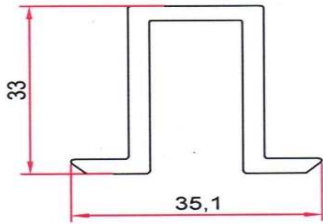
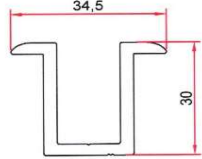
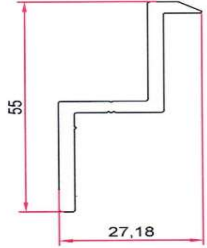
CLAMP	D22-1-001-M3-3166	338	 <p>3166 - 338 gr/m</p>
CLAMP	D22-1-002-E3-3070	547	 <p>3070 - 547 gr/m</p>
CLAMP	D22-1-003-M3-3072	867	 <p>3072 - 867 gr/m</p>
CLAMP	D22-1-004-M3-3125	749	 <p>3125 - 749gr/m</p>
CLAMP	D22-1-005-M3-8442	700	 <p>8442 - 700 gr/m</p>
CLAMP	D22-1-006-E3-8443	627	 <p>8443 - 627 gr/m</p>

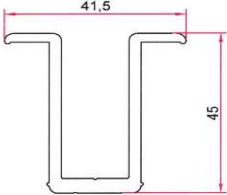
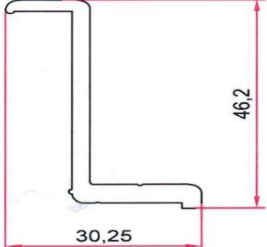
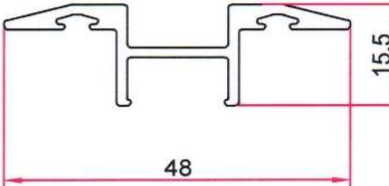
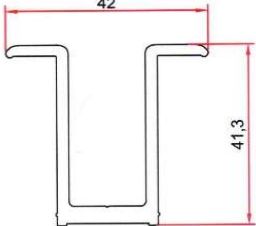
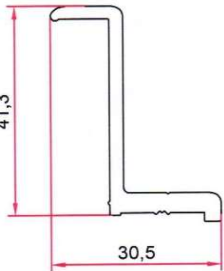
CLAMP	D22-1-007-M3-7882	967	 <p>7882 - 967 gr/m</p>
CLAMP	D22-1-008-E3-7883	596	 <p>7883 - 596 gr/m</p>
CLAMP	D22-1-009-M3-7305	389	 <p>7305 - 389 gr/m</p>
CLAMP	D22-1-0010-M3-7056	863	 <p>7056 - 863 gr/m</p>
CLAMP	D22-1-0011-E3-7057	547	 <p>7057 - 547 gr/m</p>

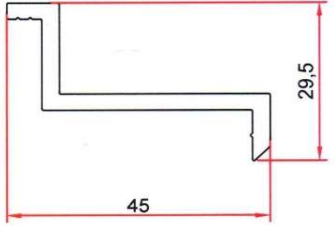
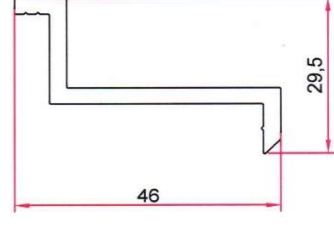
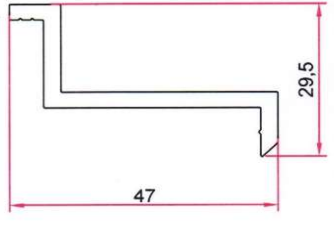
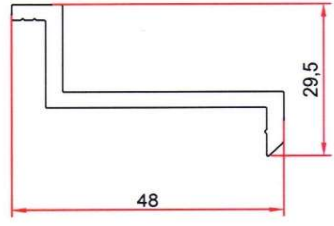
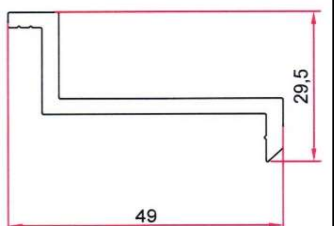
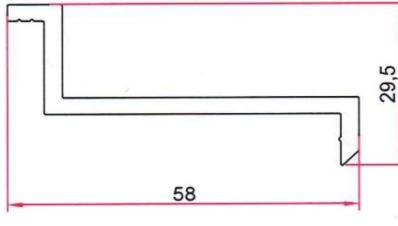
CLAMP	D22-1-0012-E3-7001	570	 <p>7001 - 570 gr/m</p>
CLAMP	D22-1-0013-E3-7002	578	 <p>7002 - 578 gr/m</p>
CLAMP	D22-1-0014-E3-7003	586	 <p>7003 - 586 gr/m</p>
CLAMP	D22-1-0015-E3-7004	594	 <p>7004 - 594 gr/m</p>
CLAMP	D22-1-0016-E3-7005	602	 <p>7005 - 602 gr/m</p>
CLAMP	D22-1-0017-E3-7007	675	 <p>7007 - 675 gr/m</p>

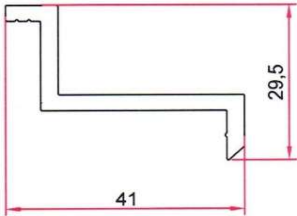
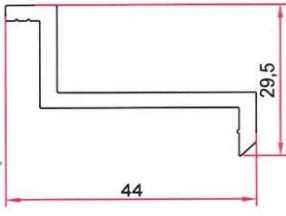
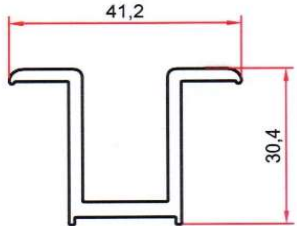
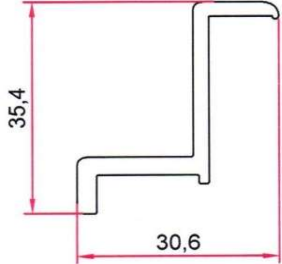
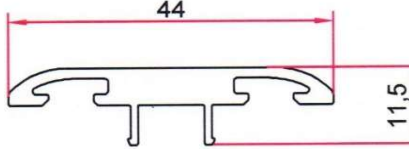
CLAMP	D22-1-0018-E3-6999	537	 <p>6999 - 537 gr/m</p>
CLAMP	D22-1-0019-E3-7000	562	 <p>7000 - 562 gr/m</p>
CLAMP	D22-1-0020-M3-6743	638	 <p>6743 - 638 gr/m</p>
CLAMP	D22-1-0021-E3-6744	454	 <p>6744 - 454 gr/m</p>
CLAMP	D22-1-0022-M3-6761	470	 <p>6761 - 470 gr/m</p>

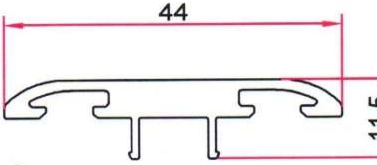
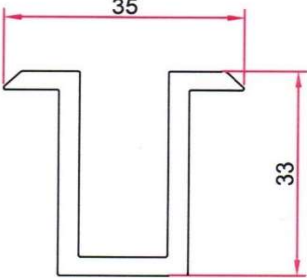
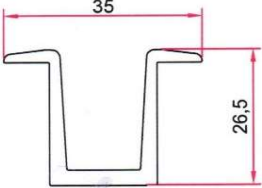
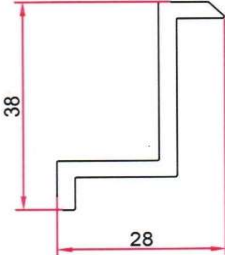
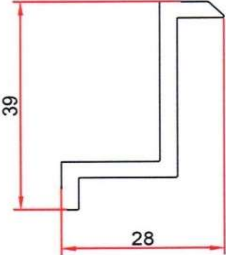
CLAMP	D22-1-0023-M3-6762	436	 <p>6762 - 436 gr/m</p>
CLAMP	D22-1-0024-M3-4326	751	 <p>4326 - 751 gr/m</p>
CLAMP	D22-1-0025-M3-4521	543	 <p>4521 - 543 gr/m</p>
CLAMP	D22-1-0026-E3-4635	502	 <p>4635 - 502 gr/m</p>
CLAMP	D22-1-0027-E3-4330	509	 <p>4330 - 509 gr/m</p>

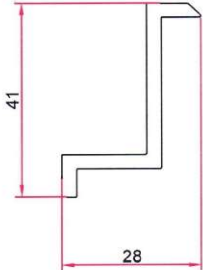
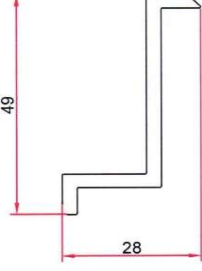
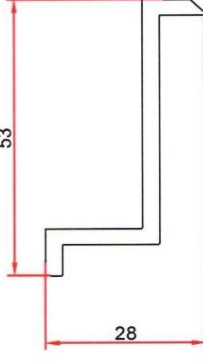
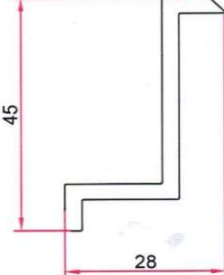
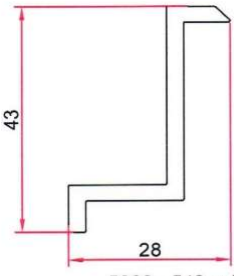
CLAMP	D22-1-0028-E3-4329	525	 <p>4329 - 525 gr/m</p>
CLAMP	D22-1-0029-E3-4328	590	 <p>4328 - 590 gr/m</p>
CLAMP	D22-1-0020-E3-4327	622	 <p>4327 - 622 gr/m</p>
CLAMP	D22-1-0031-E3-5069	559	 <p>5069 - 559 gr/m</p>
CLAMP	D22-1-0032-E3-5068	543	 <p>5068 - 543 gr/m</p>

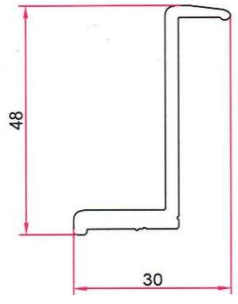
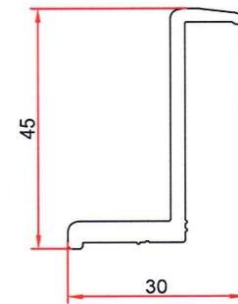
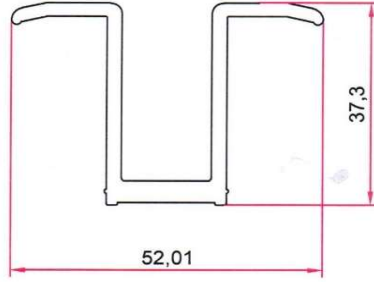
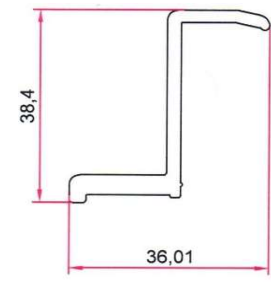
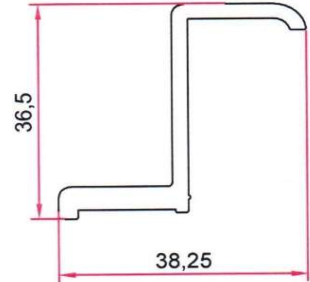
CLAMP	D22-1-0033-E3-4813	567	 <p>4813 - 567 gr/m</p>
CLAMP	D22-1-0034-E3-4683	547	 <p>4683 - 547 gr/m</p>
CLAMP	D22-1-0035-M3-5226	876	 <p>5226 - 876 gr/m</p>
CLAMP	D22-1-0036-E3-5225	556	 <p>5225 - 556 gr/m</p>
CLAMP	D22-1-0037-E3-5621	563	 <p>5621 - 563 gr/m</p>

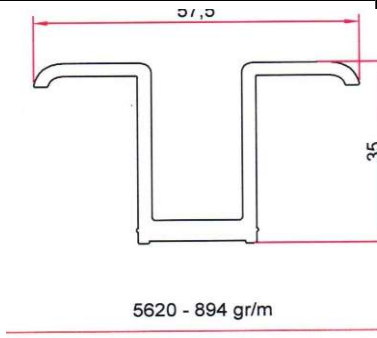
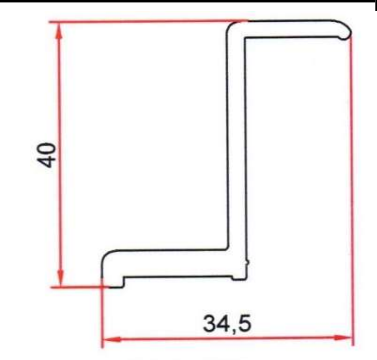
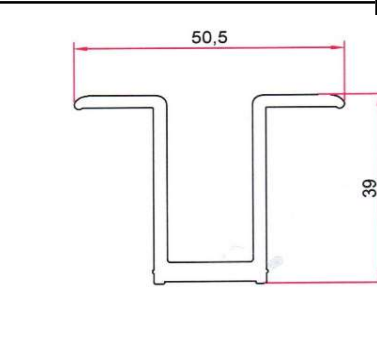
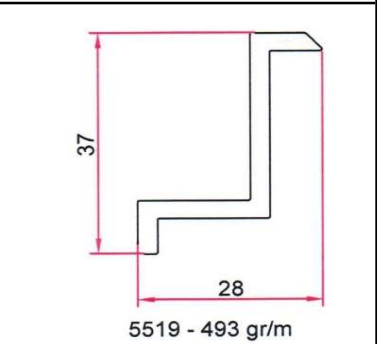
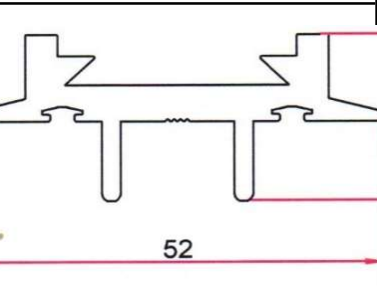
CLAMP	D22-1-0038-M3-5620	894	 <p>5620 - 894 gr/m</p>
CLAMP	D22-1-0039-E3-5619	556	 <p>5619 - 556 gr/m</p>
CLAMP	D22-1-0040-M3-5618	888	 <p>5618 - 888 gr/m</p>
CLAMP	D22-1-0041-E3-5519	493	 <p>5519 - 493 gr/m</p>
CLAMP	D22-1-0042-M3-5870	913	 <p>5870 - 913 gr/m</p>

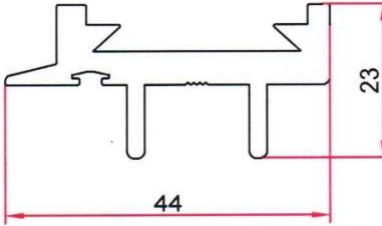
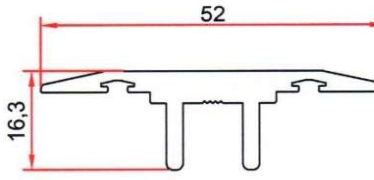
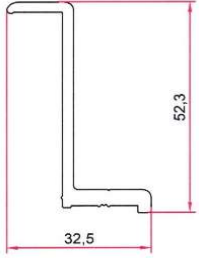
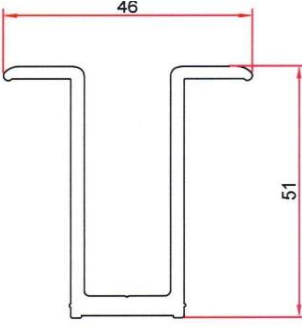
CLAMP	D22-1-0043-M3-5869	857	 <p>5869 - 857 gr/m</p>
CLAMP	D22-1-0044-M3-5868	635	 <p>5868 - 635 gr/m</p>
CLAMP	D22-1-0045-E3-5644	625	 <p>5644 - 625 gr/m</p>
CLAMP	D22-1-0046-M3-5643	1021	 <p>5643 - 1021 gr/m</p>

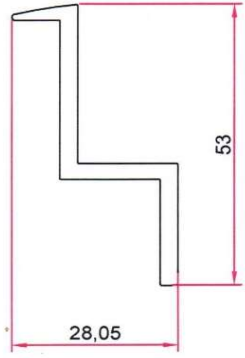
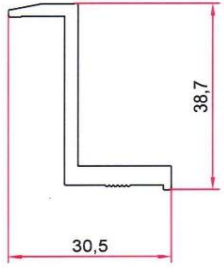
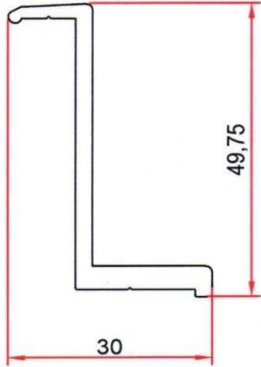
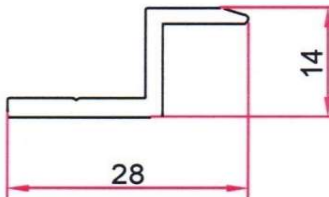
CLAMP	D22-1-0047-E3-6043	608	 <p>6043 - 608 gr/m</p>
CLAMP	D22-1-0048-E3-6012	513	 <p>6012 - 513 gr/m</p>
CLAMP	D22-1-0049-E3-5999	582	 <p>5999 - 582 gr/m</p>
CLAMP	D22-1-0050-E3-5966	234	 <p>5966 - 234 gr/m</p>

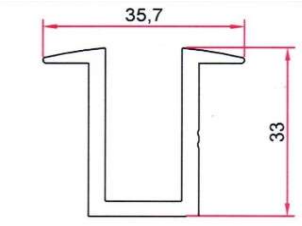
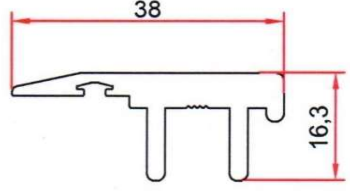
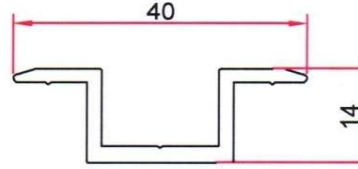
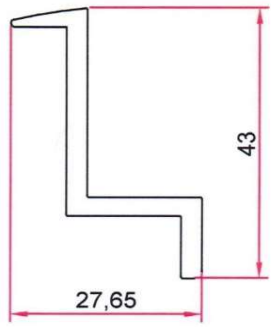
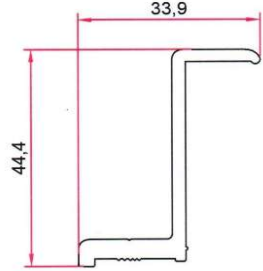
CLAMP	D22-1-0051-M3-5886	726	 <p>5886 - 726 gr/m</p>
CLAMP	D22-1-0052-M3-5871	573	 <p>5871 - 573 gr/m</p>
CLAMP	D22-1-0053-M3-5965	359	 <p>5965 - 359 gr/m</p>
CLAMP	D22-1-0054-E3-5887	524	 <p>5887 - 524 gr/m</p>
CLAMP	D22-1-0055-E3-6739	583	 <p>6739 - 583 gr/m</p>

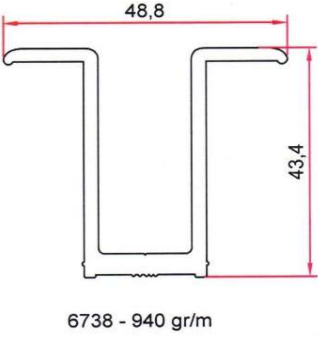
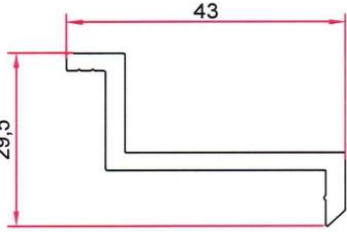
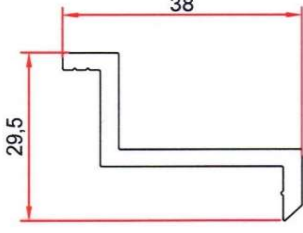
CLAMP	D22-1-0056-M3-6738	940	 <p>6738 - 940 gr/m</p>
CLAMP	D22-1-0057-E3-6594	555	 <p>6594 - 555 gr/m</p>
CLAMP	D22-1-0058-E3-6593	514	 <p>6593 - 514 gr/m</p>